

# Quarry Essentials Pocket Guide

NOVEMBER 2015



## DISCLAIMER

WorkSafe New Zealand has made every effort to ensure the information contained in this publication is reliable, but makes no guarantee of its completeness. WorkSafe may change the contents of this guideline at any time without notice.

This document is a guide only. It should not be used as a substitute for legislation or legal advice. WorkSafe is not responsible for the results of any action taken on the basis of information in this document, or for any errors or omissions.

ISBN: 978-0-478-42596-3 (print)

ISBN: 978-0-478-42595-6 (online)

Published: November 2015



Except for the logos of WorkSafe, this copyright work is licensed under a Creative Commons Attribution-Non-commercial 3.0 NZ license. To view a copy of this license, visit <http://creativecommons.org/licenses/by-nc/3.0/nz>

In essence, you are free to copy, communicate and adapt the work for non-commercial purposes, as long as you attribute the work to WorkSafe and abide by the other license terms.

# About this guide

This document provides useful information on some of the common health and safety issues in quarries. It will help you to manage these issues, and ensure the health and safety of everyone on the worksite. It is based on the Good Practice Guideline *Health and Safety at Opencast Mines, Alluvial Mines and Quarries*. References to more detailed advice are included where relevant.

This document is for quarry operators, managers and workers.

# CONTENTS

---

<b>01</b>	<b>INTRODUCTION</b>	<b>1</b>
	Hazard and Risk .....	2
	Certificates of Competency .....	3
	Clean Air .....	3
	Emergency .....	3
	Notification.....	3
<b>02</b>	<b>ROADWAYS</b>	<b>4</b>
<b>03</b>	<b>EXCAVATIONS</b>	<b>7</b>
<b>04</b>	<b>MINING IN WATER</b>	<b>13</b>
<b>05</b>	<b>MAINTENANCE</b>	<b>17</b>
<b>06</b>	<b>TRAINING</b>	<b>19</b>
<b>07</b>	<b>GUARDING</b>	<b>21</b>
<b>08</b>	<b>TIPS AND STOCKPILES</b>	<b>24</b>
<b>09</b>	<b>ELECTRICITY</b>	<b>27</b>
<b>10</b>	<b>BLASTING</b>	<b>30</b>

**01/**

---

**INTRODUCTION**

Operators should ensure that:

- > **HAZARD and RISK:** A hazard appraisal and risk assessment is carried out to provide, and through regular review, maintain:
  - a safe working environment
  - plant designed and maintained so that it is safe
  - adequate arrangements to deal with any emergencies that might occur.



Figure 1: Hierarchy of controls

---

Operators should ensure that:

- > **CERTIFICATES OF COMPETENCY:** The quarry manager holds the relevant certificate of competence.
- > **CLEAN AIR:** Workers are not exposed to contaminated or harmful air such as silica dust or chemicals that could damage their health.
- > **EMERGENCY:** Emergency services are provided with GPS coordinates and up to date information about obtaining quick access to the work site.
- > **NOTIFICATION:** If you are a quarry operator you are responsible for operating safely and notifying WorkSafe New Zealand about the nature of your operation, its location and the name of the quarry manager.  
The contact address for WorkSafe is:  
WorkSafe New Zealand, PO Box 165, Wellington 6140.  
The email address is: [hhu.extractives@worksafe.govt.nz](mailto:hhu.extractives@worksafe.govt.nz)

For more information refer to section 2 of *Health and Safety at Opencast Mines, Alluvial Mines and Quarries*.



Figure 2: Vehicle overturn emergency

**02/**

---

**ROADWAYS**



Where practicable segregate light vehicles on roads used by off road dump trucks. This is to eliminate interactions between light and heavy vehicles (see Figure 3).

The hierarchy of controls for controlling light and heavy vehicle interactions is:

1. separation (different haul road)
2. segregation (bund separation on same haul road)
3. administrative controls.

Consider the interactions of light and heavy vehicles when entering and leaving haul roads.

For more information refer to section 5 of *Health and Safety at Opencast Mines, Alluvial Mines and Quarries*.

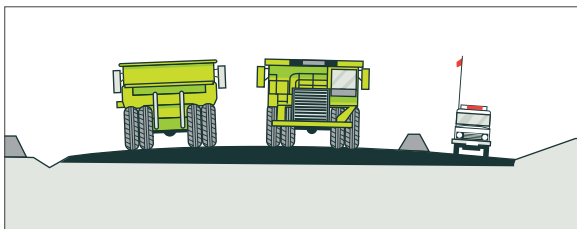

**Figure 3:** Segregation of light vehicles

Ensure roads and other vehicle operating areas are safe by their design, rather than rely on drivers' or other workers' actions.

Haul roads should have a gradient of 1:8 or less.

Ensure windrows are at least half the wheel height of the largest vehicle that operates in the area at any time.



Figure 4: Example traffic management sign

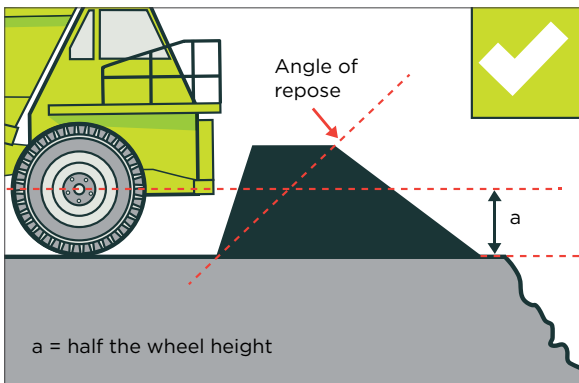

Figure 5: Suitable windrow - the width of the windrow is as wide as the normal angle of repose

**03/**

---

**EXCAVATIONS**

Ensure excavation faces and ponds are properly designed having:

- > stable slope angles
- > adequate benches
- > bench widths at least 1/2 the face height and not less than 3.5 m
- > face heights suitable for the site conditions and excavation method
- > faces that never exceed the reach of the excavator.

Never undermine faces or working benches.

Faces should be scaled to control the risk of rock falls.

As a guide:

- > Simple operations (eg shallow depth, soft material with faces less than 3.5 m, or competent rock with faces less than 15 m) require a *geotechnical appraisal* by a competent person to determine that the face design is safe, adequate benching is in place, and confirm that a geotechnical assessment is not required.
- > Complex operations (eg individual faces exceeding 15 m, overall excavation depth exceeding 30 m, fractured rock, disturbed geological structure) require a *geotechnical assessment* by a competent person.

For more information refer to section 3 of *Health and Safety at Opencast Mines, Alluvial Mines and Quarries*.

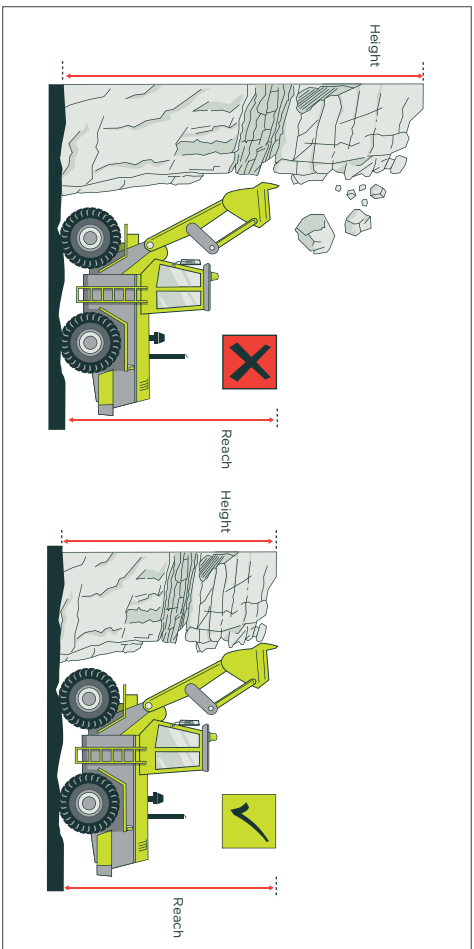

**Figure 6:** Face height should not exceed the reach of the loader used on the face

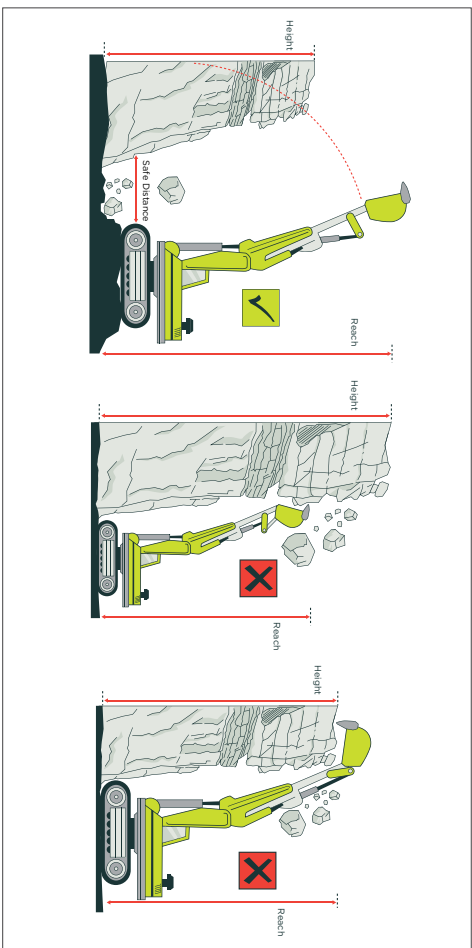

**Figure 7:** Face height should not exceed the reach of the excavator used on the face, with safe operating distances

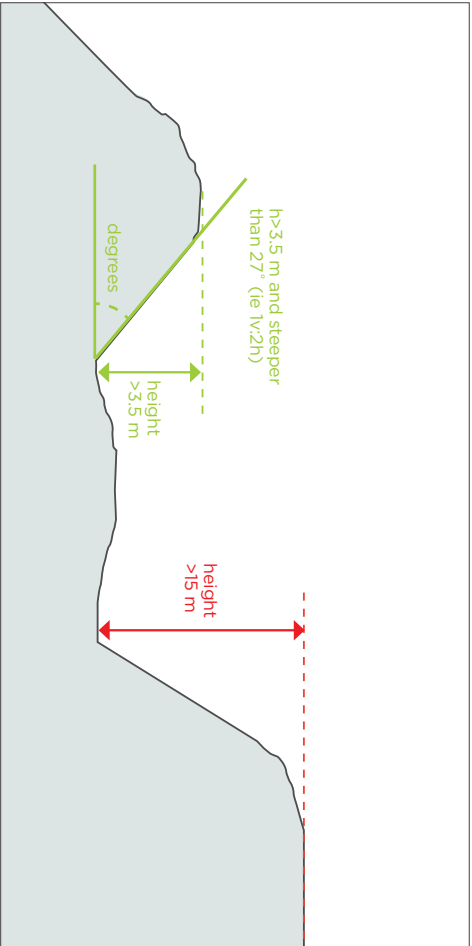

Figure 8: 'Soils and very weak rock' guidance

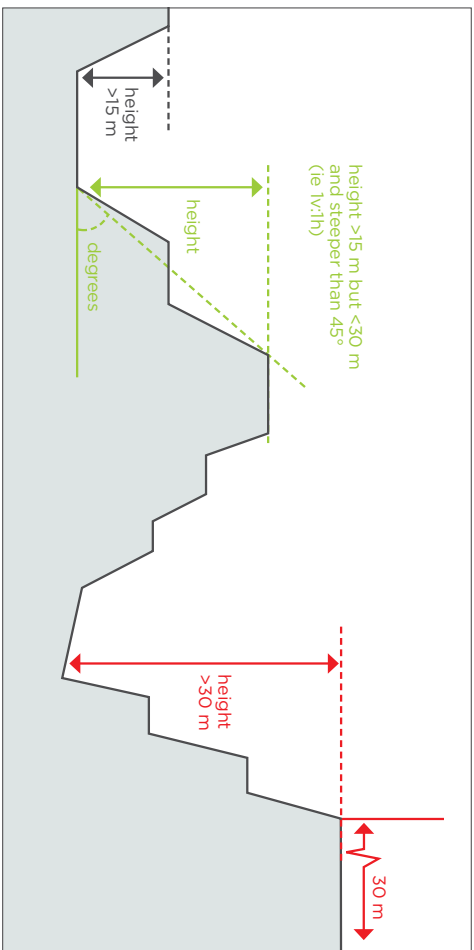

Figure 9: 'Stronger rock' guidance



**04/**

---

**MINING IN WATER**

Ensure ponds and waterborne mining systems are designed to:

- > prevent failure of containment structures
- > provide safe access to floating platforms and dredges (eg walkways and handrails)
- > not become unstable due to shifting loads or being overloaded
- > remain stable while being towed
- > remain water worthy in operating conditions.

Ensure life jackets are worn when persons are accessing floating plant. Do not have personnel on board floating plant while it is fed by an excavator.

For more information refer to section 9 of *Health and Safety at Opencast Mines, Alluvial Mines and Quarries*.

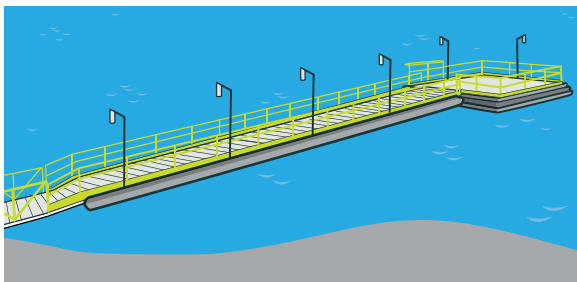

**Figure 10:** Example of gangway with guardrails

---

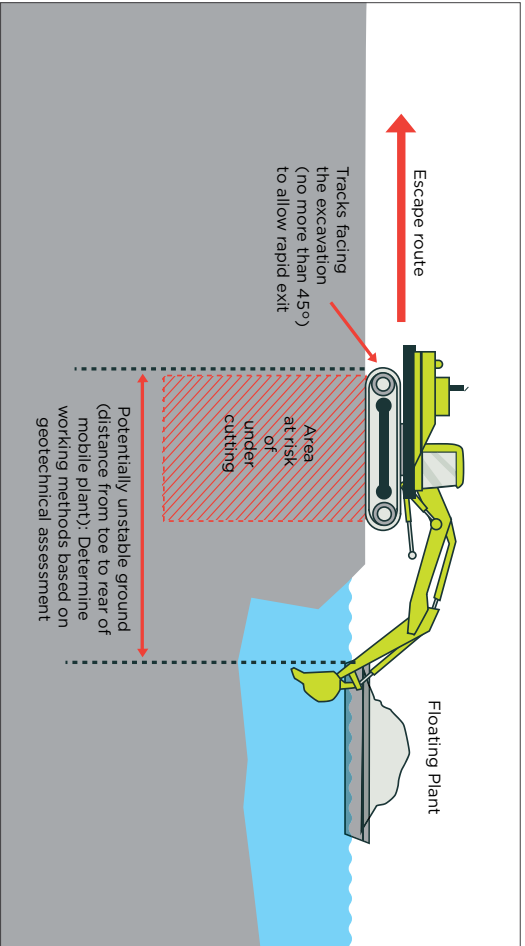

**Figure 11:** Excavator working beneath water, loading floating plant

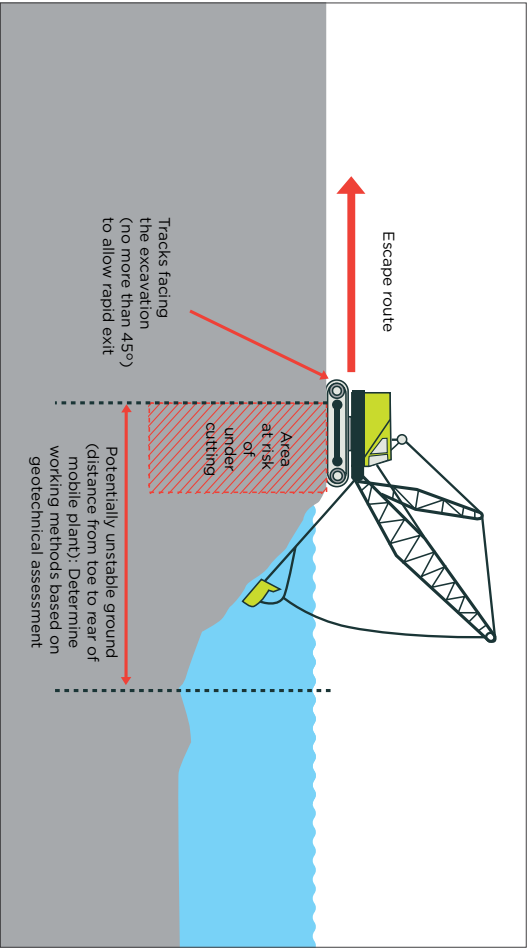

Figure 12: Dragline working beneath water

**05/**

---

**MAINTENANCE**

Ensure all mobile plant and fixed equipment is:

- > listed in a maintenance schedule
- > maintained in a safe condition.

Regularly test brakes on dump trucks.

Mobile and relocatable equipment at quarries must be assessed yearly against AS/NZS 3007 by a qualified mining electrical inspector.

Provide good access to plant for both normal operation, and maintenance. Include appropriate fall protection when doing so.

For more information refer to section 17 of *Health and Safety at Opencast Mines, Alluvial Mines and Quarries*.



**Figure 13:** This excavator has a good access system, with platforms, guardrails, kick plates and ladder. The ladder is interlocked so the vehicle cannot be started without the ladder being raised

---

**06/**

---

**TRAINING**

Ensure plant operators and excavator and truck driver are trained. Keep written training records.

A quarrying manager at a site where more than four workers ordinarily work at any one time must hold an A-grade certificate of competence as a quarry manager. Otherwise, they must hold a minimum of a B-grade certificate of competence as a quarry manager.

More information on what is required for a certificate of competence is available on [worksafe.govt.nz](https://www.worksafe.govt.nz).

For more information refer to section 1.6 of *Health and Safety at Opencast Mines, Alluvial Mines and Quarries*.





**07/**

---

**GUARDING**

Ensure moving parts of conveyors, screens and crushers are protected with guards bolted in position.

Ensure belt conveyors are fitted with nip guards on head and tail drums, and also where persons are exposed to conveyor bottom idlers. Provide in guard nip guarding where guards are removed for maintenance.

Ensure emergency 'lock-out' buttons and tensioned pull wires are provided along accessible parts of conveyor belts.

For more information refer to section 12.8 of *Health and Safety at Opencast Mines, Alluvial Mines and Quarries*.

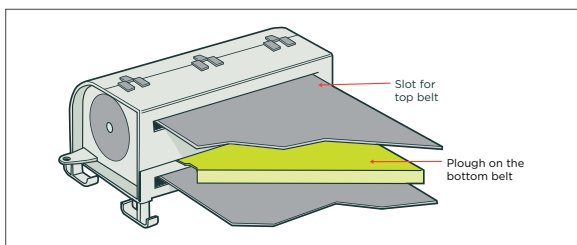

**Figure 14:** Tail drum return nip guard

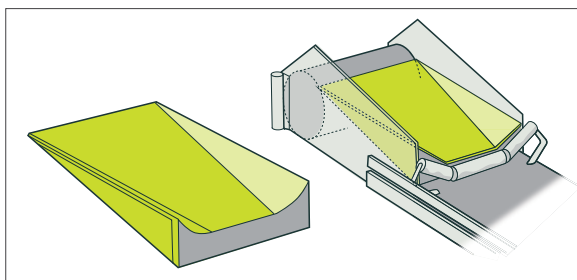

**Figure 15:** Head drum nip guard

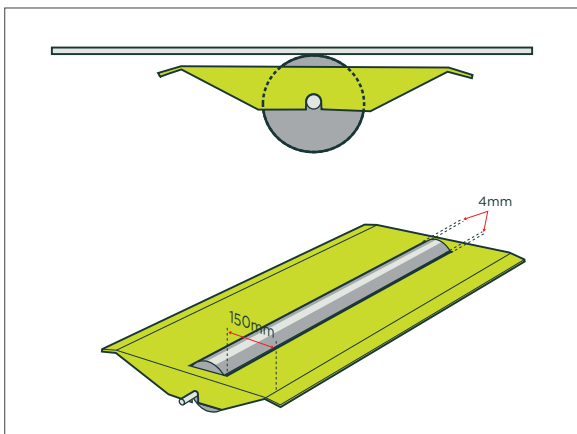

Figure 16: Bottom idler nip guard



Figure 17: Emergency stop with signs

**08/**

---

**TIPS AND  
STOCKPILES**

Only undertake end-tipping where:

- > A geotechnical assessment of every tip with a minimum factor of safety of 1.2 has been undertaken.
- > Tips and tip heads (including windrows) are formally designed, formed from consolidated layers, and terraced or stepped back to minimise fall risks.
- > The edge and windrows are systematically maintained while end-tipping.
- > The windrow is used as a visual guide only. The windrow should not be used to help stop the truck but only as a visual guide to judge where to stop (refer figure 18).
- > There is adequate supervision of dumping operations to make sure unsafe conditions are being corrected and safe practices are being followed.
- > There are specified intervals for reviewing the end-tipping, and auditing of the processes.

Ensure unusual material (eg weaker or wetter) is treated differently than standard overburden. Unusual material should always be paddock dumped in an area where it will not compromise tip stability.

End-tipping into water is not to be undertaken, in any circumstance.

If working during darkness ensure adequate fixed lighting towers are installed.

For more information refer to section 8 of *Health and Safety at Opencast Mines, Alluvial Mines and Quarries*.

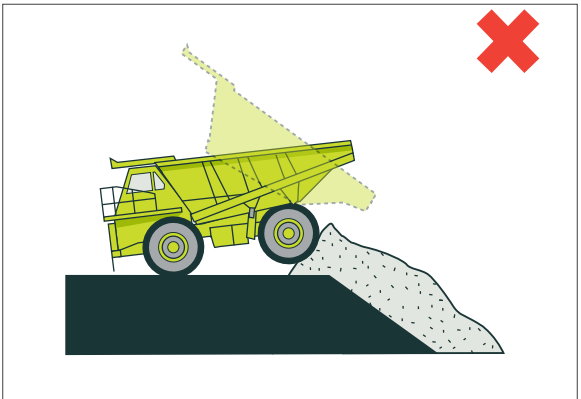
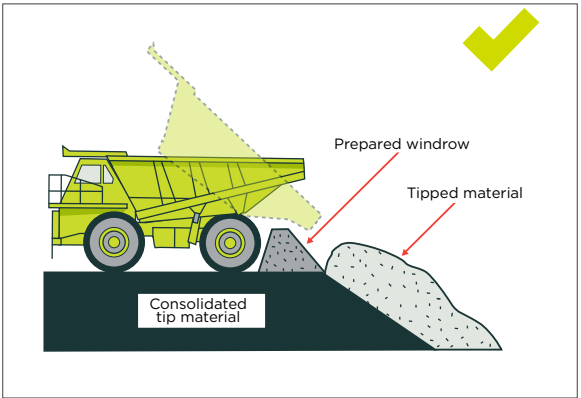

Figure 18: Approaching tip point windrow

09/

---

**ELECTRICITY**

Ensure electrical plant, cables and equipment are installed, maintained and tested to a satisfactory standard by a qualified electrician, with an annual safety certificate issued.

Provide warning poles and flags cautioning of overhead power lines.

Mobile and relocatable equipment at quarries must be assessed yearly against AS/NZS 3007 by a qualified mining electrical inspector.

For more information refer to section 12.12 of *Health and Safety at Opencast Mines, Alluvial Mines and Quarries*.



**Figure 19:** Flexible cords with tags



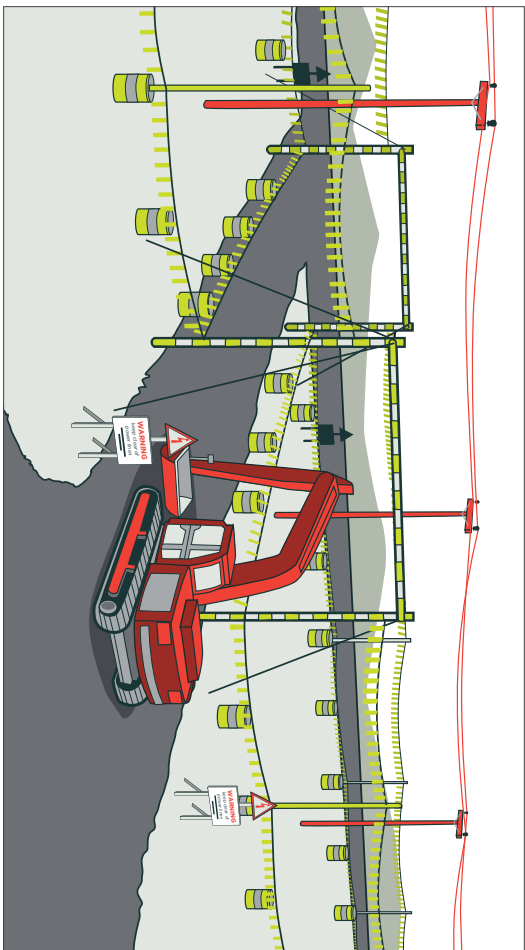

Figure 20: Safe working under overhead power lines

**10/**

---

**BLASTING**

Define the roles of the blast charger and approved handler in charge of the blast.

Ensure blasting follows a blast-design provided by a qualified person and shots detonated by the identified blast charger.

Modern Ammonium Nitrate based explosives are very safe when handled correctly, they can however explode if subjected to prolonged heating under confinement. Hazardous situations include: dry running or dead heading pumps, fire encroaching on process equipment or storage areas and contamination by incompatible chemicals.

Record all blast-holes containing water. Charge wet blast holes with water-resistant explosive (eg explosives with high levels of emulsion). This reduces the risk of a misfire.

Misfired shots and any unexploded detonators or primers should only be dealt with by a qualified blasting engineer.

For more information refer to section 6 of *Health and Safety at Opencast Mines, Alluvial Mines and Quarries*.







**WorkSafe New Zealand**

Level 6

86 Customhouse Quay

PO Box 165

Wellington 6140

New Zealand

Phone: +64 4 897 7699

Fax: +64 4 415 4015

0800 030 040

[www.worksafe.govt.nz](http://www.worksafe.govt.nz)

 @WorkSafeNZ